

YOGA POSES



YOGA POSES

YOGA INVERSION POSES

SITTING IN A CHAIR

SITTING ON THE FLOOR

JUST BE

RITUAL PRAYER

HOPE

SHOULDER ROTATIONS

BANANA

HUMILITY

EMBRACE LIFE

CRESCENT MOON

WILLOW

SQUARE

DRAWBRIDGE

WALL ANCHOR

STRENGTH

TWISTER

FAITH

MOUNTAIN

SOURCE

THE STANCE

YIN YANG LUNGE

PRACTICE BALANCE STAND

TANGO DANCER

HALFBRIDGE

L STAND

LEG BACK

UNIVERSE REACH

GENTLE JACK KNIFE



YOGA POSES PAGE 2

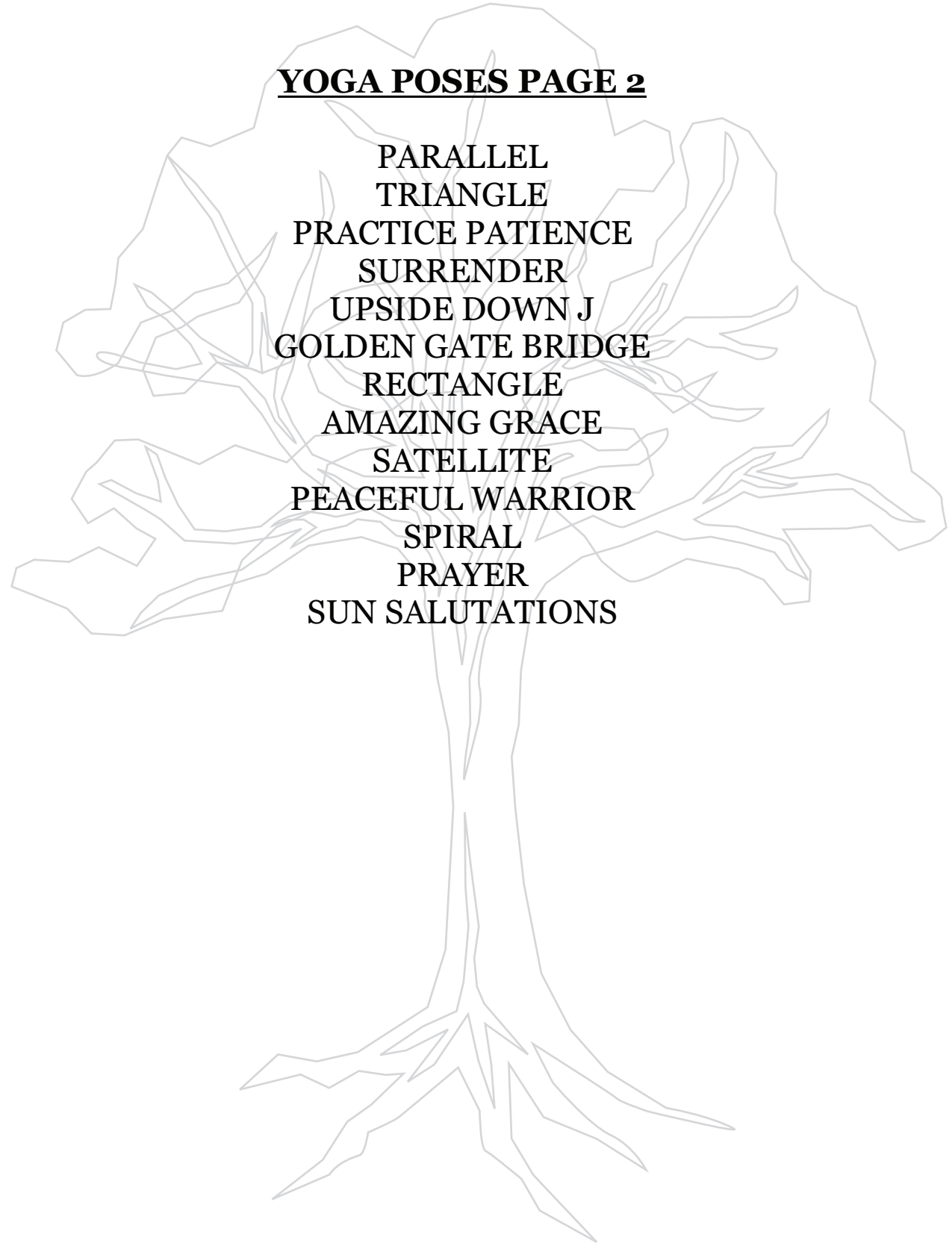

PARALLEL
TRIANGLE
PRACTICE PATIENCE
SURRENDER
UPSIDE DOWN J
GOLDEN GATE BRIDGE
RECTANGLE
AMAZING GRACE
SATELLITE
PEACEFUL WARRIOR
SPIRAL
PRAYER
SUN SALUTATIONS



MAKEOVERS LIFE FITNESS YOGA POSES INTRODUCTION

Yoga is a form of exercise that unites breath, mind, body, and spirit. The word and practice YOGA conjures up images of Eastern philosophy and ancient practices. Modern day yoga practice has been discovered in the Western world by many people who want to strengthen their bodies in a new way. Yoga is not the fast pace cardiovascular workout like running, dance class, or a sport like tennis. Yoga is learning how to slow your thoughts way down, place all your attention on the present moment, and create an oasis of stillness in your movements. Striking a yoga pose builds strength in every part of your body. It reconnects you to your higher spirit while your body and mind learn to BE still.

Breathing:

The most important part is learning the yoga practice of breathing. The automatic shallow breathing we do everyday is not the way. The correct way is to inhale through your nose as you begin counting at an even pace. One... two...three...four. Take in as much air into your lungs as you possibly can and hold it for a brief moment. Your abdomen or belly should expand as you are taking a big breath of air. Let the flow of breath into your chest and belly. When you reach the number four exhale just as slowly and evenly counting backwards. Four...three...two...one.

Placing all attention on breathing gives your thoughts a way to defuse so that you can concentrate on the task at hand-doing your yoga practice. As thoughts come up, let them pass like cars on the highway. As soon as you realize that your attention has wandered off from your breathing, bring it back gently to this important work. Teaching yourself to do this will move mountains in terms of your ability to control where your attention goes throughout the day off of your yoga mat as well.

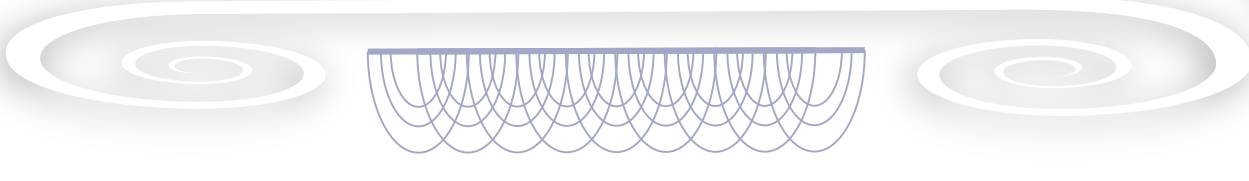



MAKEOVERS LIFE FITNESS YOGA POSES INTRODUCTION

The result in learning to concentrate on your breath during yoga practice is a feeling. It is a feeling of something familiar- peace and surrender. You will know this feeling when you come upon it. Only through patience and practice will this be disclosed to you. Your mind now becomes a tool. You may use it to reshape your thoughts and therefore, your actions as well. Fear fades and peace grows.

In conclusion, your breath should be graceful and steady. It is even more important than the form of the pose itself. Inhale on opening the body. Exhale when releasing and closing the body.

The process of each pose:

The process of a yoga session may be compared to cooking a recipe. It takes many different ingredients to create a dish. Each one serves its purpose for making the food taste good. In yoga, each pose is like an ingredient to create a soothing session that will make the body stronger and the mind more peaceful. The inversion poses give your mind and body a chance to shift into the yoga mindset. It stretches your limbs and creates a sense of familiarity on what you expect your mind and body to do next. Stretching your body and stretching your mind. Slow stretching is wonderful. Your body enjoys it and awakens it gently.

Babies and children yawn and stretch gracefully each time they awaken-even newborns. They round their backs and stretch their arms and legs in sheer satisfaction.

The yoga poses in the Makeovers Fitness program are designed to offer you a well rounded yoga session.





MAKEOVERS LIFE FITNESS YOGA POSES INTRODUCTION

To start:

- Start each session with establishing how many breath counts you wish to do per pose.
- As a beginner, you may start with two breath counts per pose. Spend two to three weeks on two breath counts per pose. Let your strength grow. Learn to create pockets of peace in your thoughts.
- Increase to four breath counts per pose. Give it time and listen to your inner compass. Spend approximately two to three weeks on four breath counts per pose.
- Work your way up to ten breath counts per pose. Take your time. Reaching this level of stamina takes patience and practice.

Strive for it. It's well worth it. Yoga is a workout for your body and it is also a work in for your spirit .

Yoga Inversion Poses

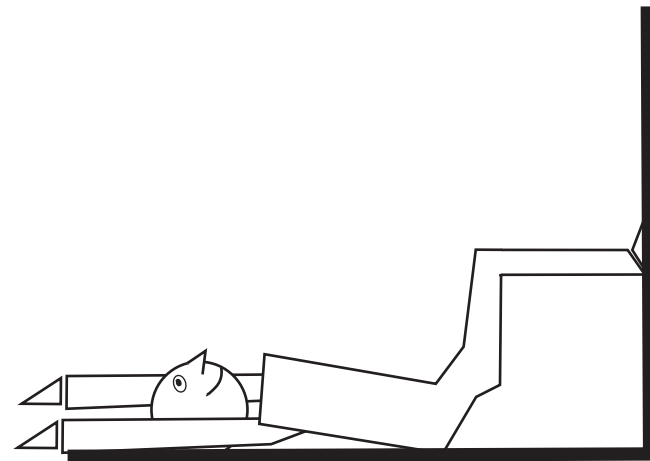
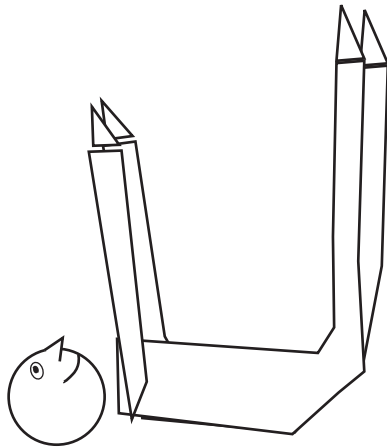
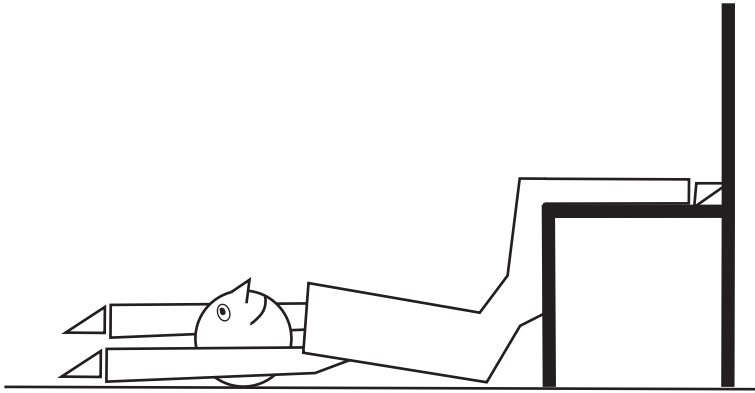

Yoga Inversion Poses

1

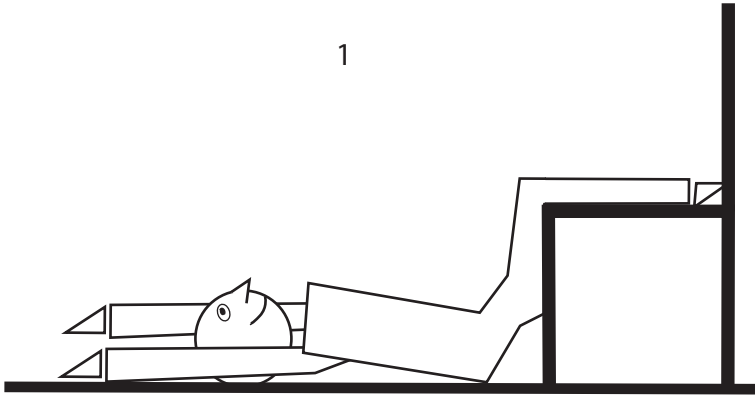

3

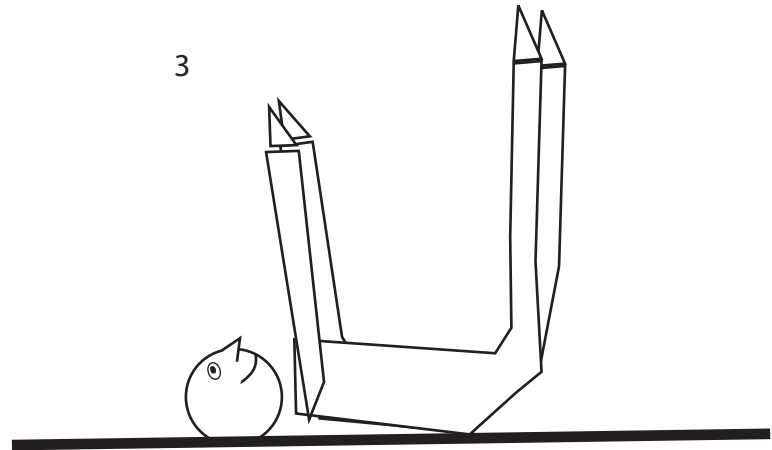

2

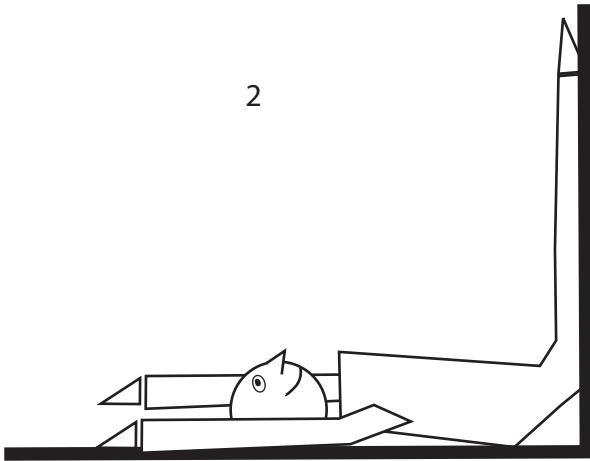

4

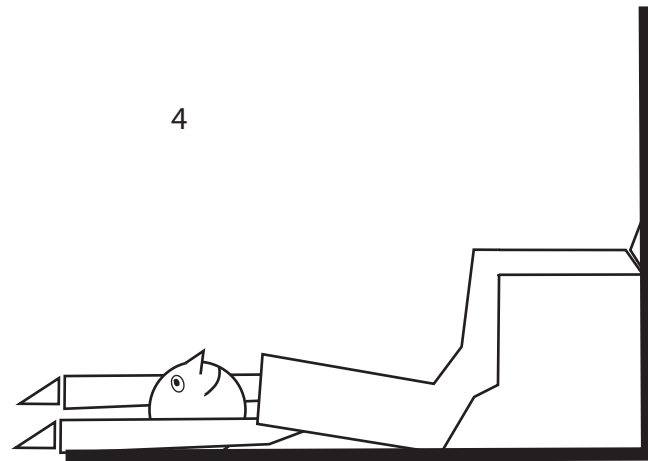

Yoga Inversion Poses

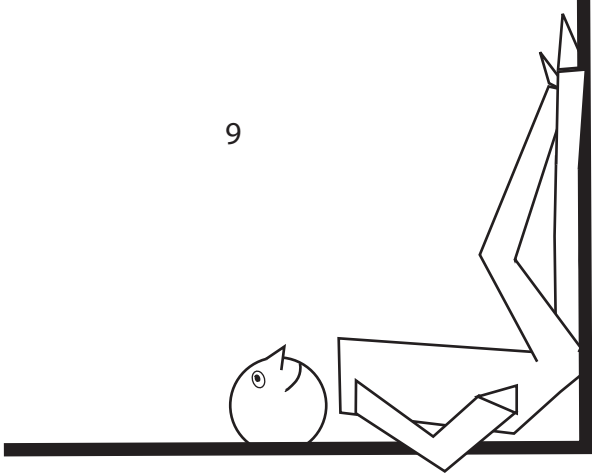
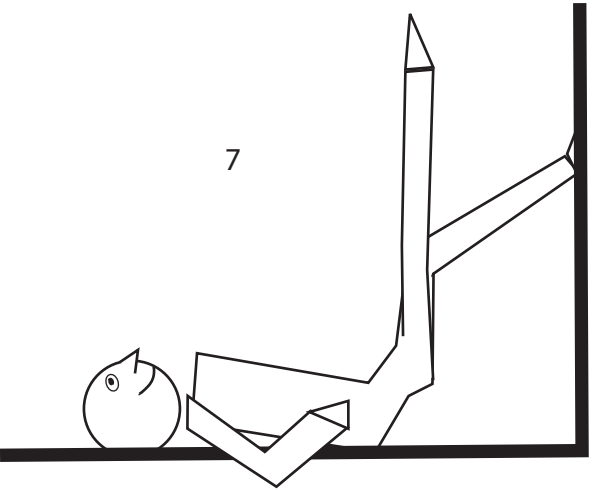
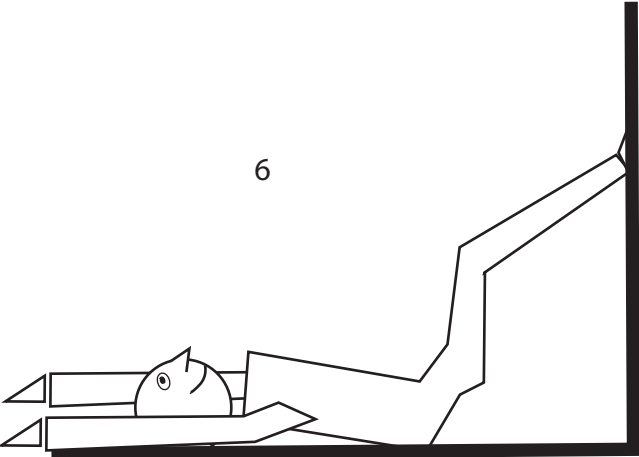
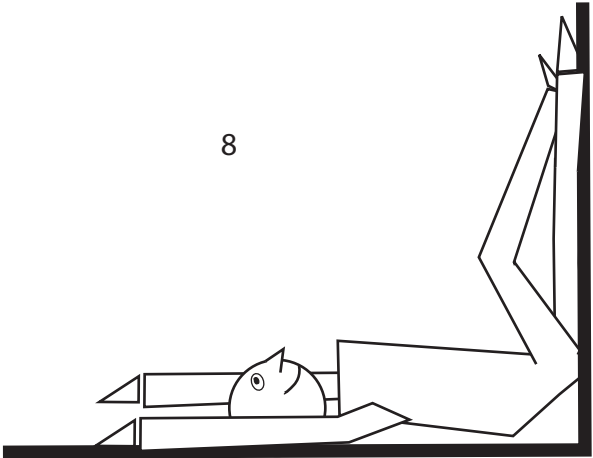
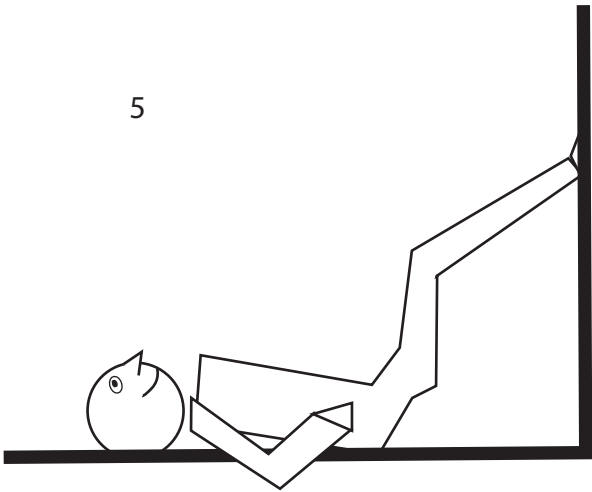

Sitting in a Chair

1. Sit straight in a chair.
2. Place hands on knees.
3. Hold for 10 breath counts.

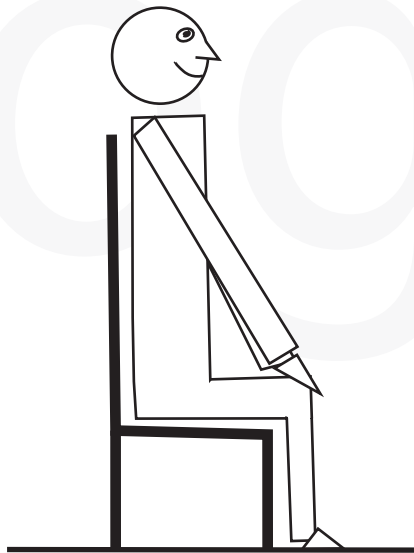

Sitting on the Floor

1. Sit on floor, legs crossed.
2. Place hands on knees.
3. Hold for 10 breath counts.

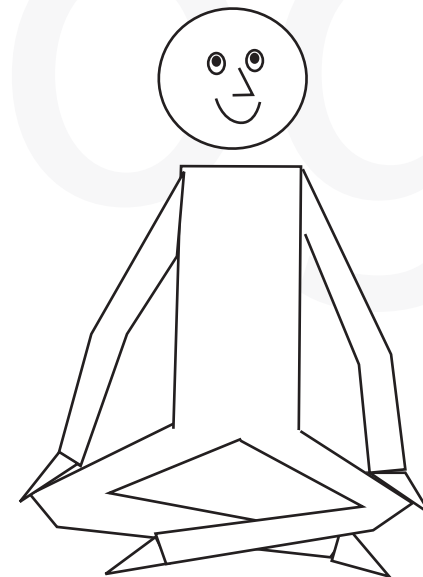

Just Be Pose

1. Begin with the Sitting On Legs Pose.
2. Move feet out keeping knees together.
3. Butt on floor.
4. Hands on thighs .
5. Hold pose for breath counting.
6. Work to 10 breath counts.

Side view

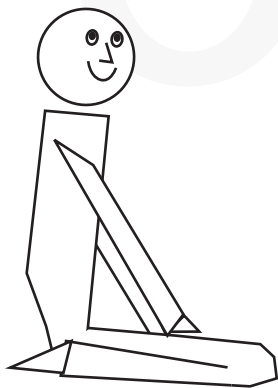

Front view

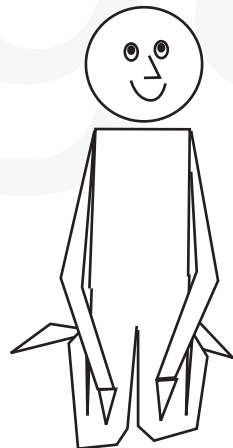

Ritual Prayer Pose

1. Begin with the Sitting On Legs Pose.
2. Bend over till head rests on floor.
3. Extend hands out towards feet.
- 4 Hold for breath counting.
5. Work to 10 breath counts.

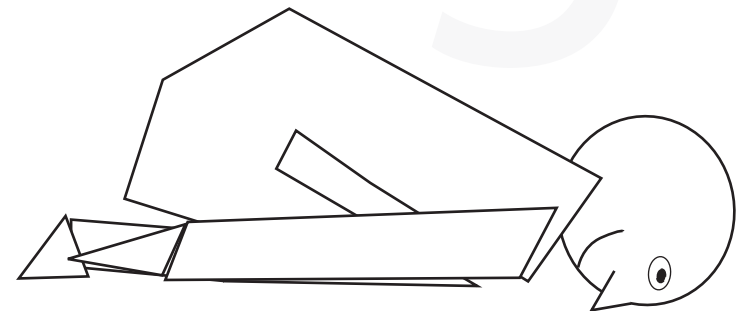

Hope Pose

1. Lay on floor, face down .
2. Place palms face down at sides.
3. Bring hands up by shoulders.
4. Lift shoulders straight up.
5. Face is looking upward.
3. Hold for 10 breath counts.



Shoulder Rotations

1. Stand in Mountain Pose.
2. Roll shoulders up and forward.
3. Roll shoulders down and back.
3. Reverse direction. That's a rep.
4. Work to 10 reps/set.

Forward

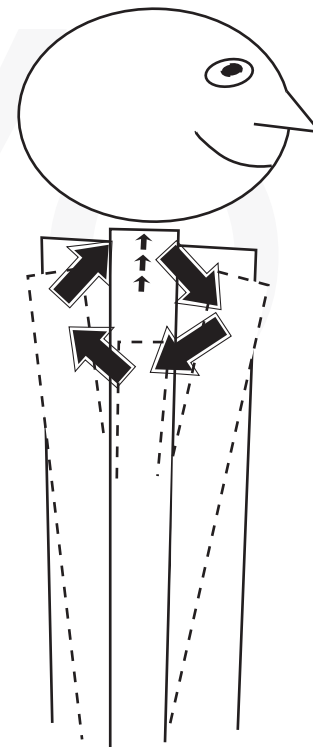

Reverse

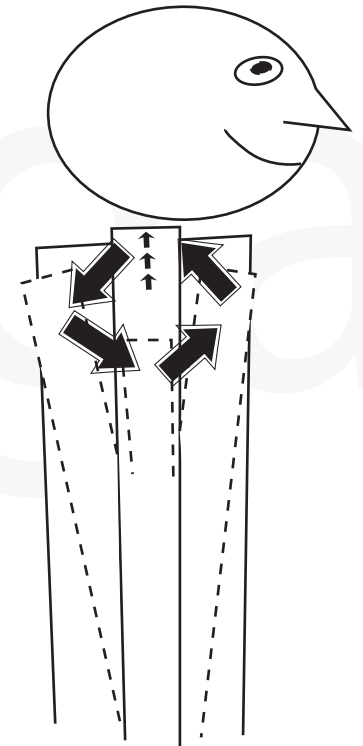

Banana Pose

1. Begin on hands and knees.
2. Back is straight.
2. Lower belly to ground, bending back.
3. Hold for breath counting.
4. Arch back as high as possible.
5. Hold for breath counting.
6. Work to 10 breath counts.

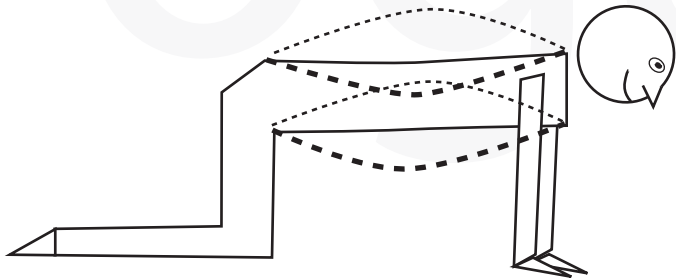

Humility Pose

1. Reach hands out as far as possible.
2. Lower head and chest to ground.
3. Hold for breath counting.
4. Work to 10 breath counts.

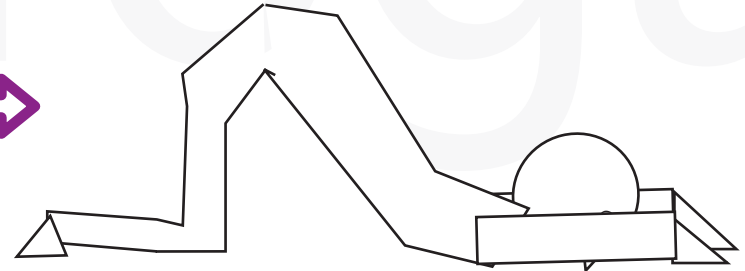

Yogda Yogda

Embrace Life Pose

1. Lay down on back.
2. Pull knee to chest.(A)
3. Hold for breath counting.
4. Switch to other leg.(B)
5. Hold for breath counting.
6. Pull both knees to chest.(C)
7. Hold for breath counting.

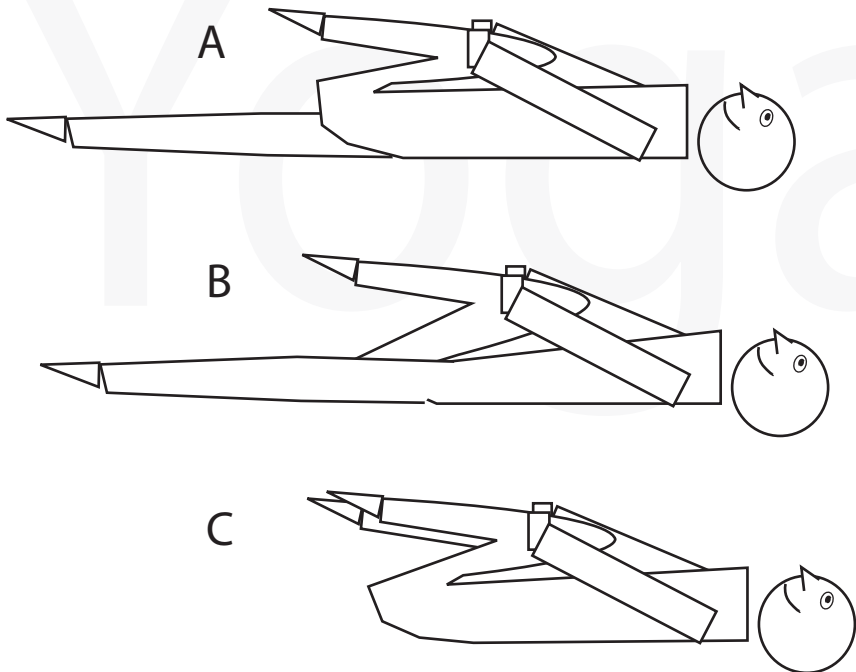

Crescent Moon

1. Stand straight .
2. Raise hands above head.
3. Bend back as far as you can.
4. Hold for breath counting.
5. Work to 10 breath counts.

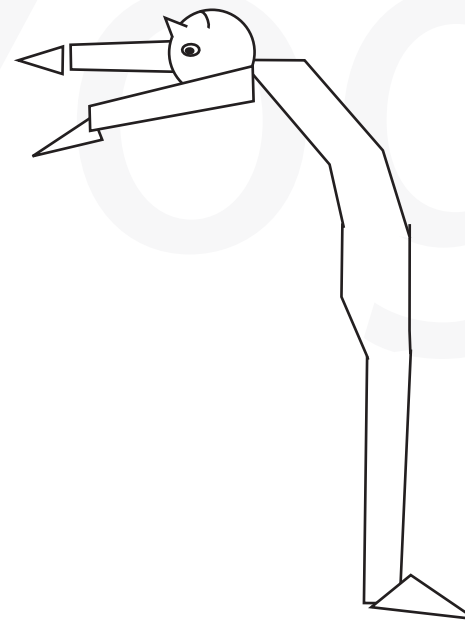

Willow Pose

1. Stand straight.
2. Raise arms over head.
3. Lower your upper body slowly.
4. Reach down as far as possible. (A)
5. Keep knees soft.
6. Place hands around ankles.(B)
7. Hold pose for breath counting.
8. Work to 10 breath counts.

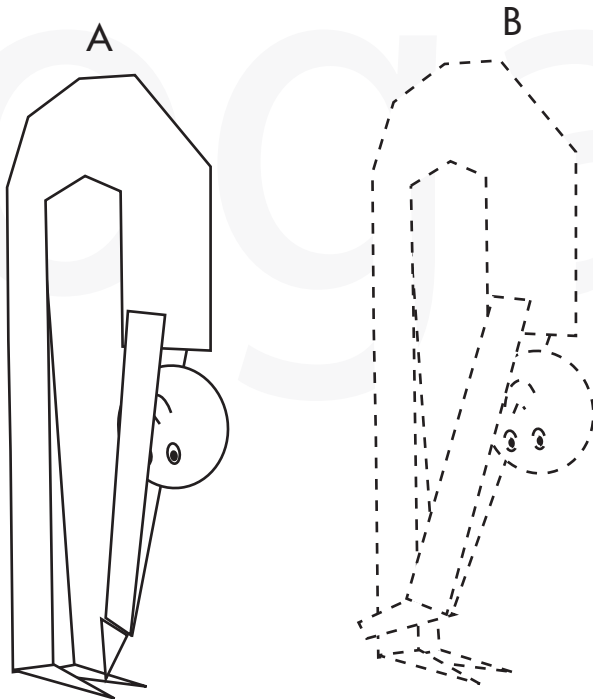

Square Pose

1. Stand facing a wall.
2. Bend forward placing palms flat against the wall.
3. Keep knees soft.
4. Hold pose for breath counting.
5. Work to 10 breath counts.

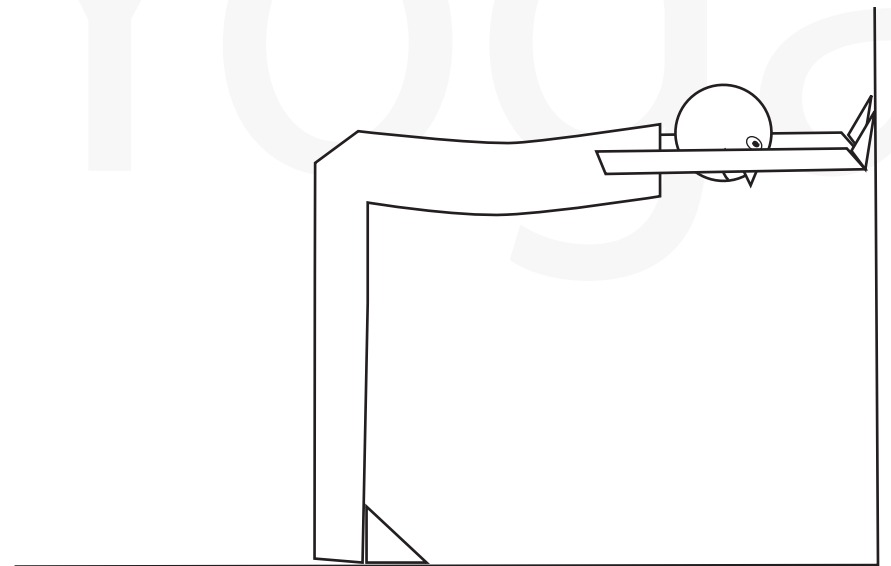

Drawbridge Pose

1. Begin in a girl's push up position.
2. Straighten legs, raising bottom straight up.
3. Hold for breath counting.
4. Lower back down to girl's push up position.
5. Hold for breath counting.
6. Work to 10 breath counts.

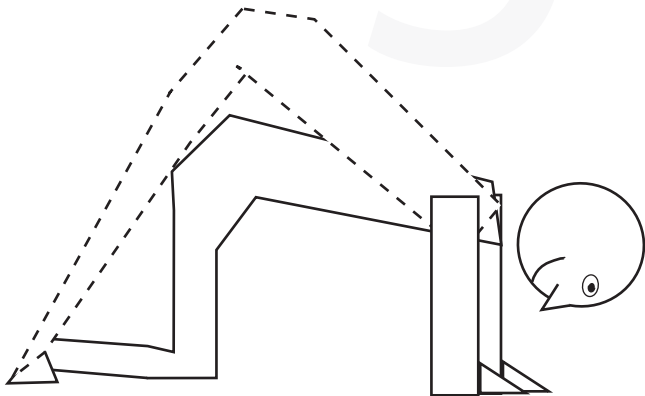

Wall Anchor Pose

1. Stand on hands and knees facing a wall.
2. Place both hands flat against the wall.
3. Reach one leg out.
4. Hold for breath counting.
5. Switch to other leg.
6. Hold for breath counting.
7. Work to 10 breath counts.

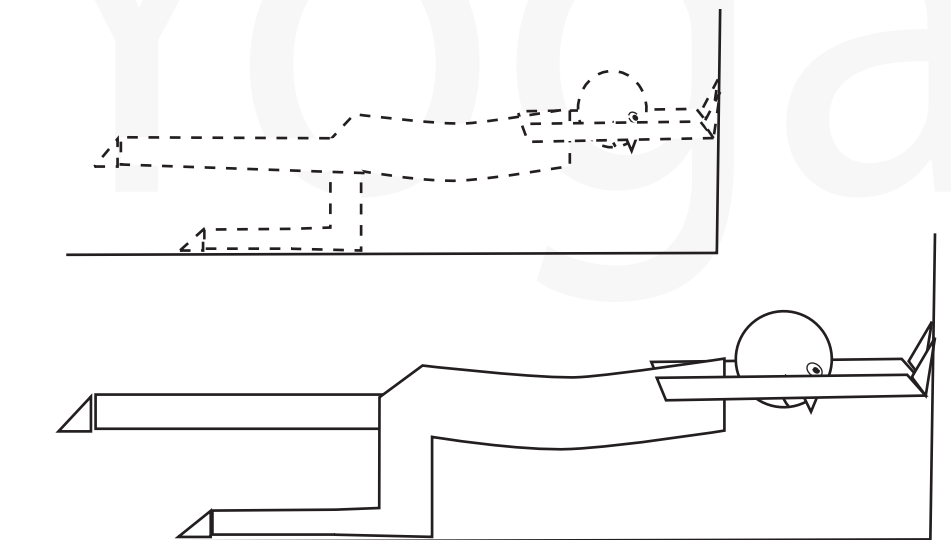

Strength Pose

1. Stand up on hands and knees.
2. Pull leg into chest.
3. Hold for breath counting.
4. Extend leg back and up.
5. Hold for breath counting.
6. Switch to other leg.

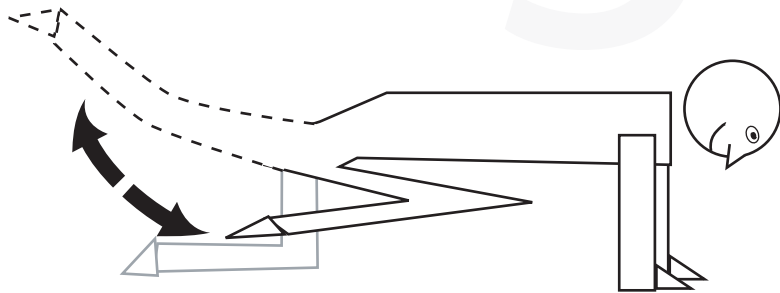

Twister Pose

1. Begin laying down, arms stretched to sides.
2. Bend right knee.
3. Bring right leg over left leg.
4. Place left hand over right knee.
5. Hold for breath counting.
6. Switch to other leg.
7. Work to 10 breath counts.

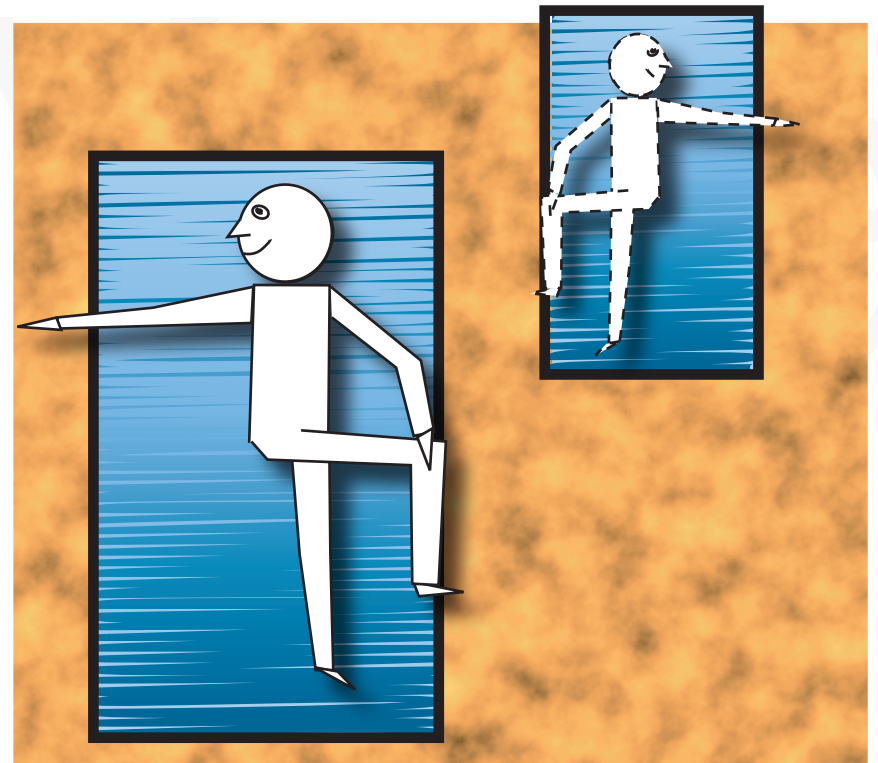

Faith Pose

1. Sit on floor, feet tucked under bottom.
2. Place palms on knees.
3. Hold for 10 breath counts.

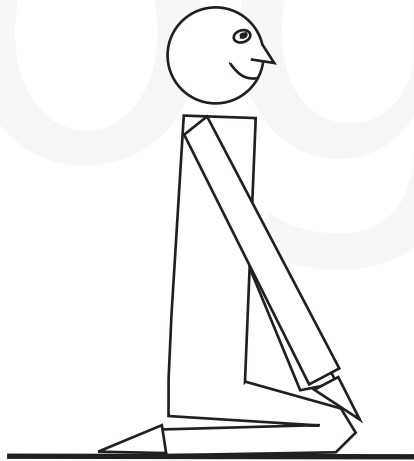

Mountain Pose

1. Stand tall, feet apart.
2. Place hands at sides.
3. Hold for 10 breath counts.

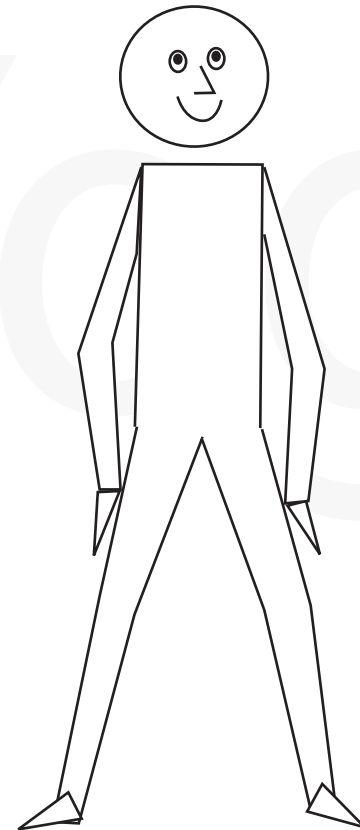

Source Pose

1. Stand straight .
2. Raise hands above head, palms resting against each other.
3. Raise one leg out sideways, bending knee.
4. Place bottom of foot on inner portion of other leg.
5. Hold for breath counting.
6. Switch to other leg.
7. Hold for breath counting.
8. Work to 10 breath counts.

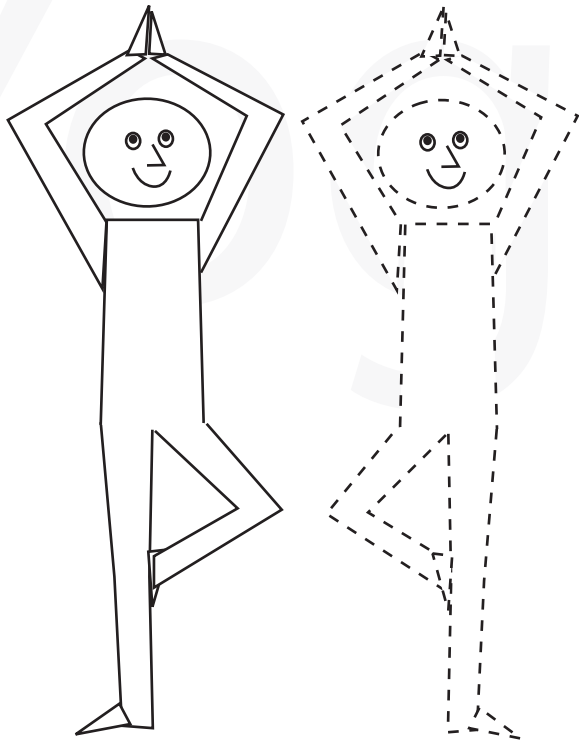

The Stance

1. Stand in Mountain Pose.
2. Raise arms straight out to sides.
3. Raise knee up so that upper leg is perpendicular to body.
5. Hold for breath counting.
6. Switch to other leg.
7. Hold for breath counting.
8. Work to 10 breath counts.

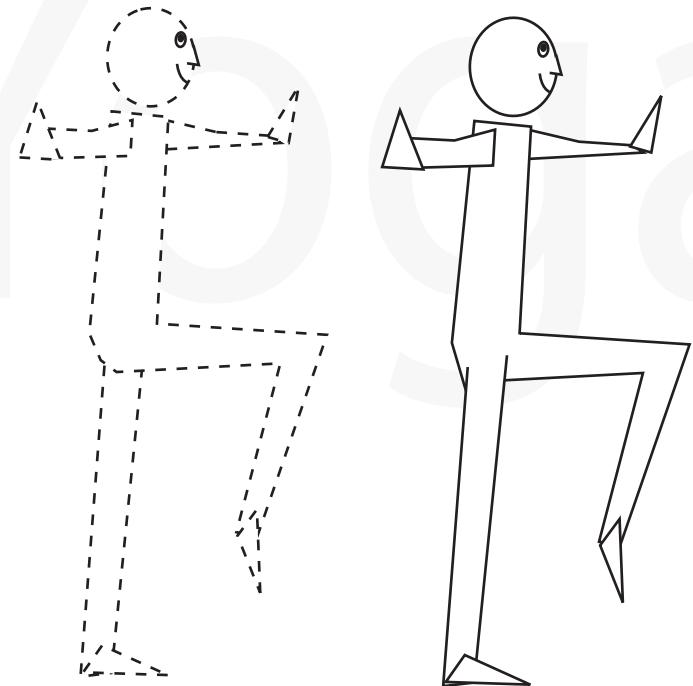

Yin Yang Lunge

1. Stand with feet apart.
2. Step one leg forward into a lunge.
3. Twist upper body to one side.
4. Rest elbow on thigh.
5. Put palms together.
6. Hold pose for breath counting.
7. Switch to other leg.
8. Work to 10 breath counts.

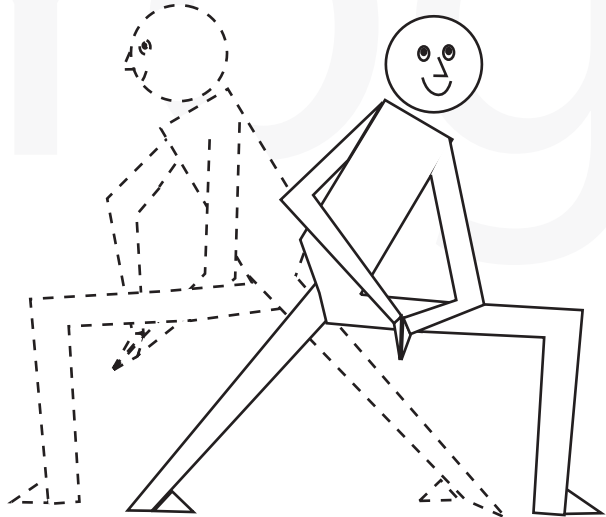

Practice Balance Stand

1. Stand with feet apart.
2. Put arms over head.
3. Raise one leg back.
4. Hold pose for breath counting.
5. Switch to other leg.
6. Work to 10 breath counts.

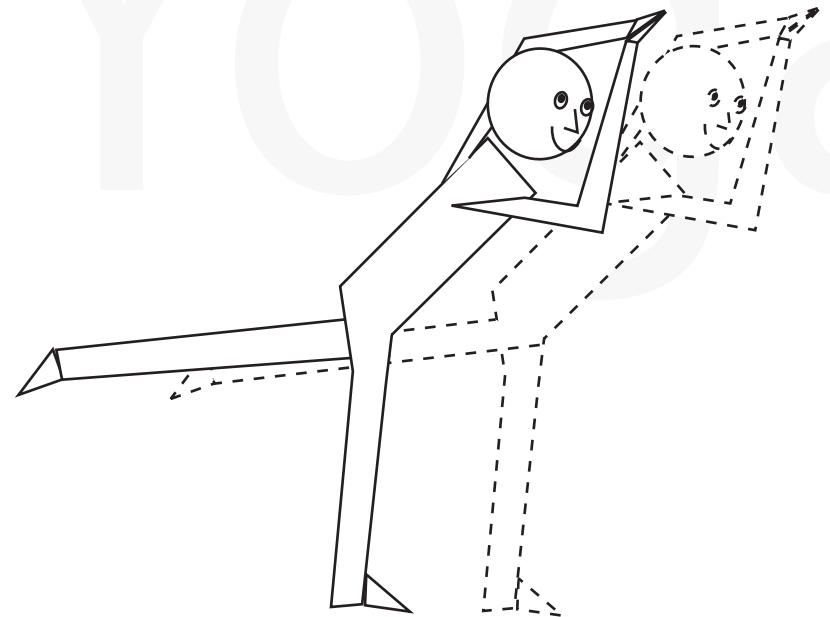

Tango Dancer Pose

1. Stand with feet apart.
2. Lift left leg straight back.
3. Hold left ankle with left hand.
4. Reach up with right hand looking upward.
5. Hold pose for breath counting.
6. Switch to other leg.
7. Work to 10 breath counts.

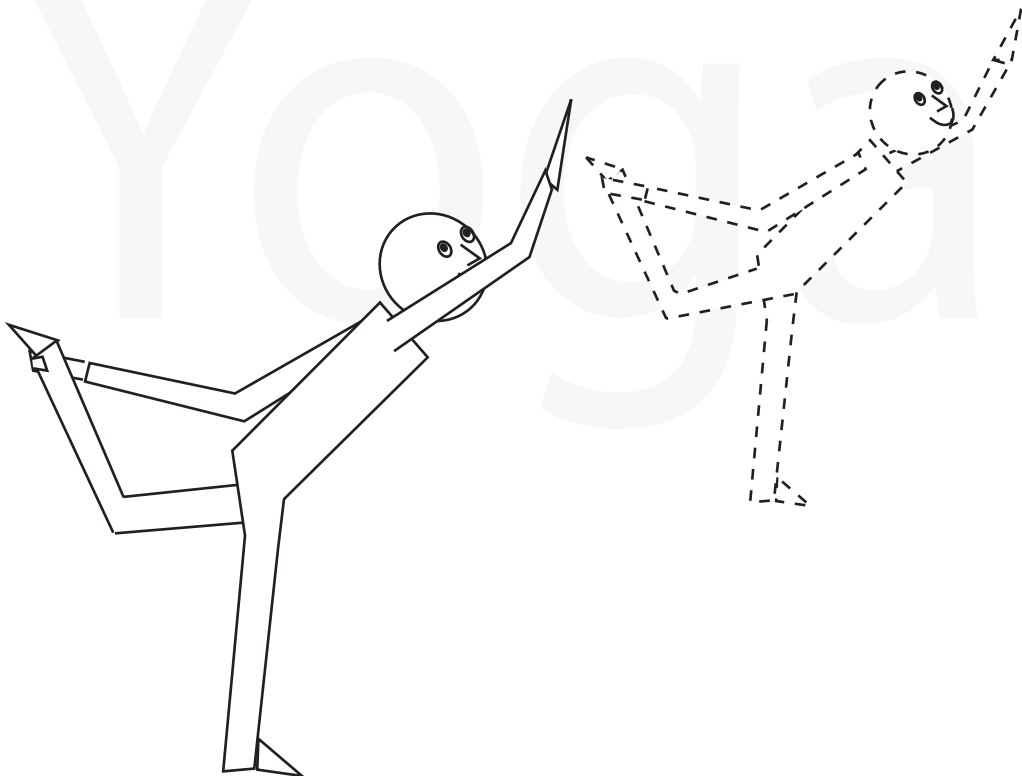

Half Bridge

1. Lay on your back.
2. Bend knees.
3. Keep feet flat.
4. Push upper body up.
5. Butt and back off the floor.
6. Lay arms down on floor.
7. Place hands together.
8. Hold pose for breath counting.
9. Work to 10 breath counts.

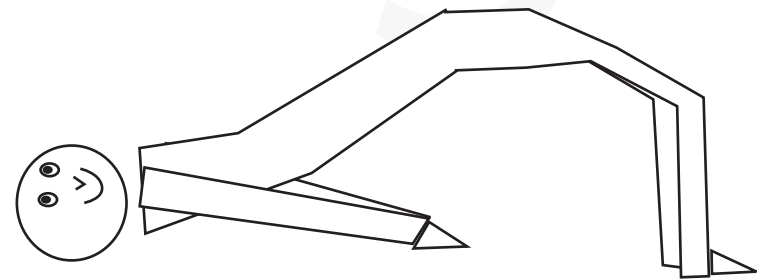

L Stand

1. Stand with feet apart.
2. Grab leg with both hands.
3. Arch chest forward.
4. Straighten leg .
5. Hold pose for breath counting.
6. Switch to other leg.
7. Work to 10 breath counts.

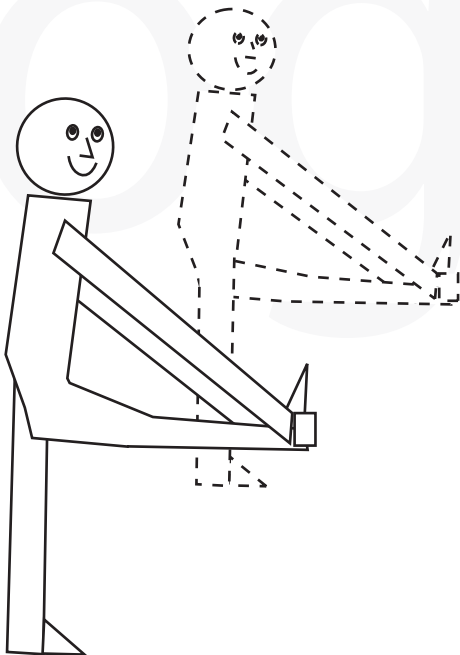

Leg Back Pose

1. Sit with legs stretched out.
2. Fold one leg under.
3. Extend other leg out straight behind you.
4. Butt on floor .
5. Arms by your sides.
6. Hold for breath counting.
7. Switch to other leg.
8. Work to 10 breath counts.

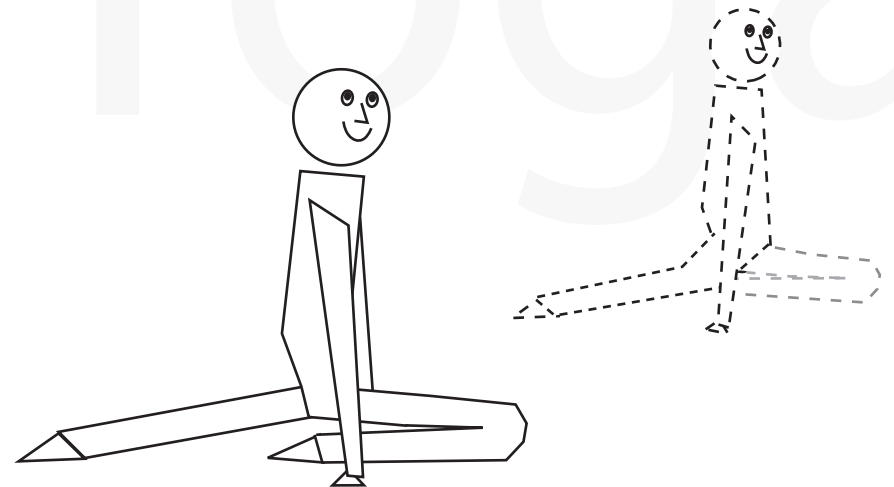

Universe Reach

1. Lay down on your back.
2. Put your arms up straight.
3. Lift your shoulders off the ground and reach to the sky.
4. Repeat.
5. Work up to 10 reps/set.

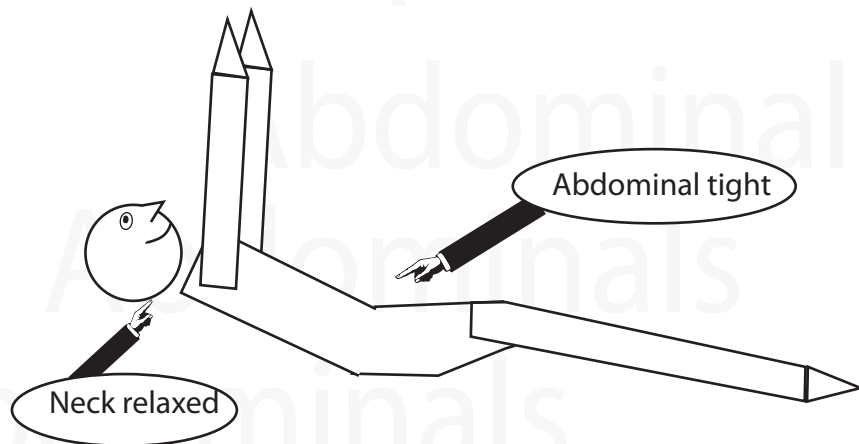

Gentle Jack Knife

1. Lay down on your side.
2. One leg extended.
3. One leg bent.
4. Foot on floor behind straight leg.
5. Extend one arm.
6. The other hand behind head.
7. Gently lift your upper torso off the floor.
8. Gently lower your upper torso to the floor.
9. Work up to 10 reps/set.

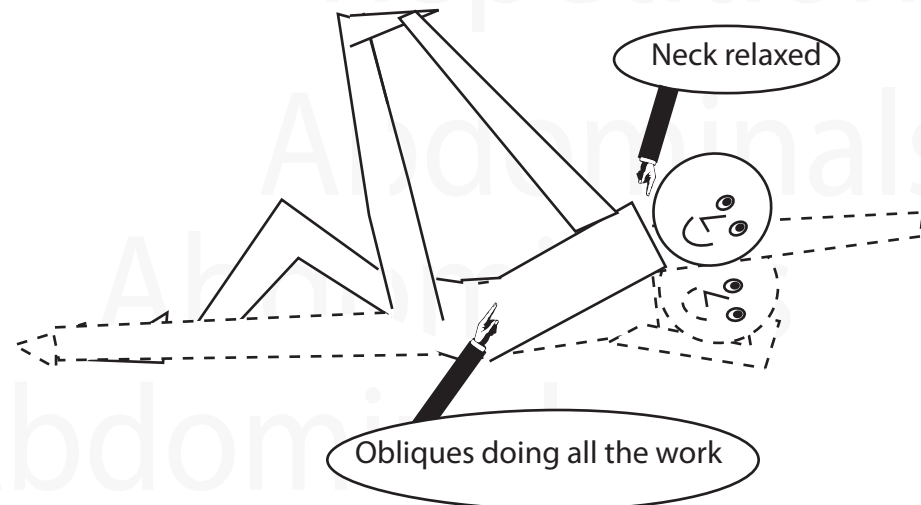

Parallel Pose

1. Lay on floor face down.
2. Raise up on hands and knees.
3. Extend one arm up over head.
4. Extend leg on opposite side parallel to floor.
5. Hold for breath counting.
6. Switch to other arm and leg.
7. Work to 10 breath counts.

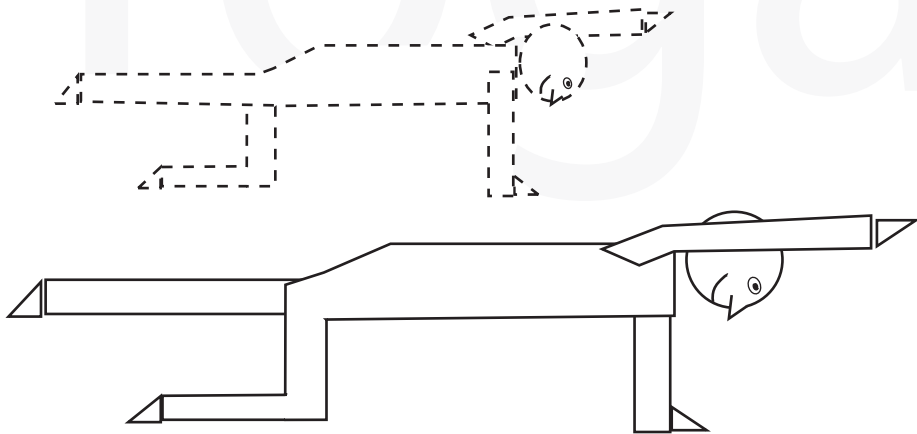

Triangle Pose

1. Stand with legs apart.
2. Bend over.
3. Place hands on floor.
4. Lift one leg up.
5. Keep it straight.
6. Hold for breath counting.
7. Switch to other leg.
8. Work to 10 breath counts.

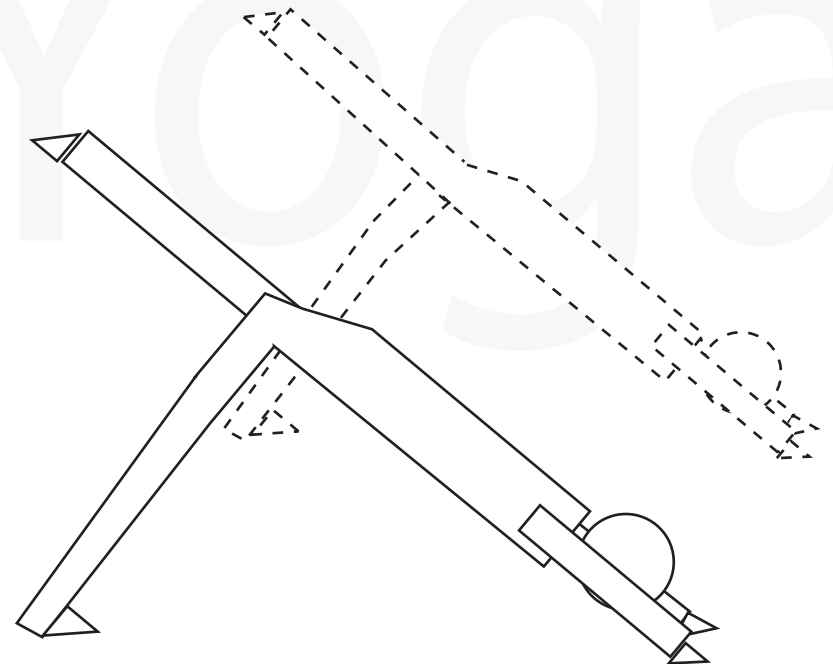

Practice Patience Pose

1. Lay on your back.
2. Swing legs over head.
3. Reach upward with toes until your body is in a straight line.
4. Use arms to help get in position.
5. Put arms down on floor.
6. Place hands together.
7. Hold pose for breath counting.
8. Work to 10 breath counts.

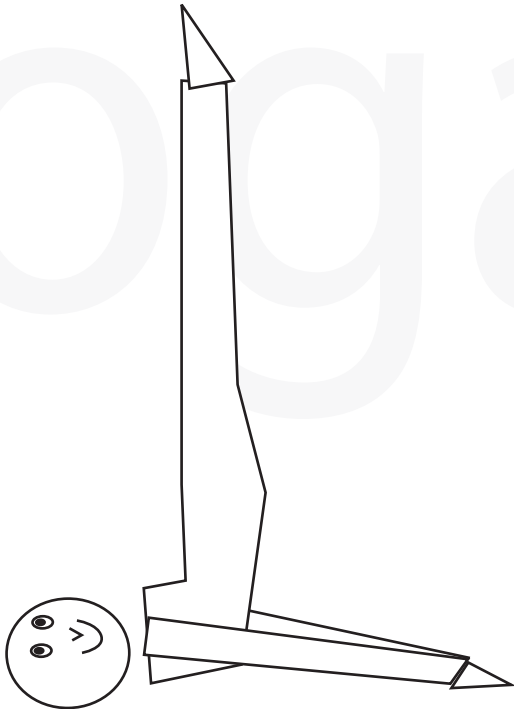

Surrender Pose

1. Lay on your back.
2. Push shoulders up.
3. Bend head back.
4. Touch crown of head to floor.
7. Place hands together.
8. Hold pose for breath counting.
9. Work to 10 breath counts.

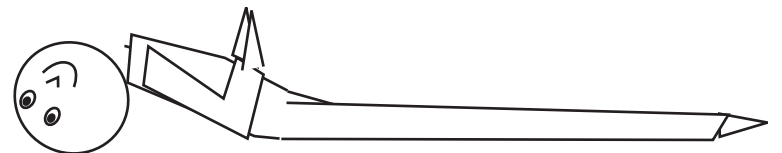

Upside Down J Pose

1. Lay on your back.
2. Swing legs over head.
3. Push your back until toes touch floor.
4. Use arms to help get in position.
5. Put arms down on floor.
6. Place hands together.
7. Hold pose for breath counting.
8. Work to 10 breath counts.

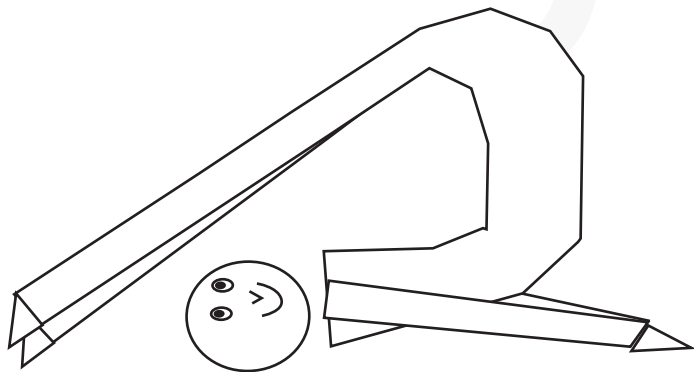

Golden Gate Bridge

1. Lay on your back.
2. Bend knees.
3. Keep feet flat.
4. Push lower body up.
5. Butt and back off the floor.
6. Place hands behind head.
7. Push upper body up - head off floor.
8. Hold pose for breath counting.
9. Work to 10 breath counts.

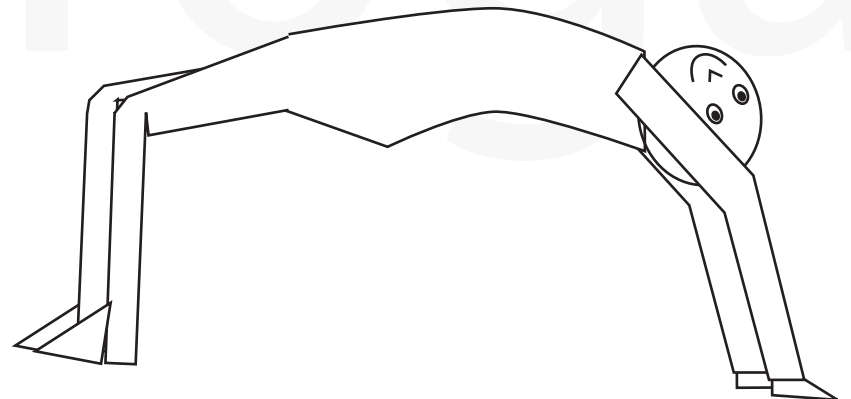

Rectangle Pose

1. Lay on your back.
2. Raise up on hands and feet.
3. Keep back straight.
4. Extend one arm straight up .
5. Hold for breath counting.
6. Switch to other arm.
7. Work to 10 breath counts.

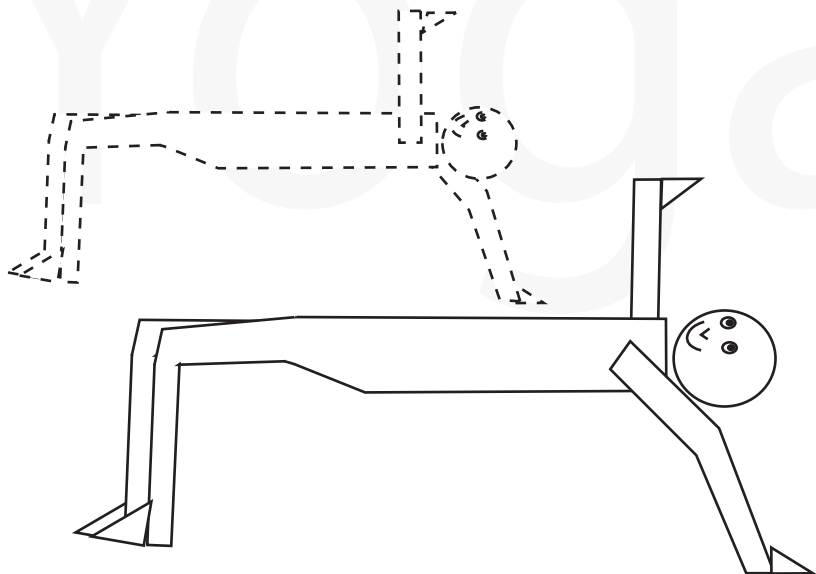

Amazing Grace Pose

1. Stand with feet apart.
2. Step one leg forward into a lunge.
3. Put hands together behind you.
4. Hold pose for breath counting.
5. Switch to other leg.
6. Work to 10 breath counts.

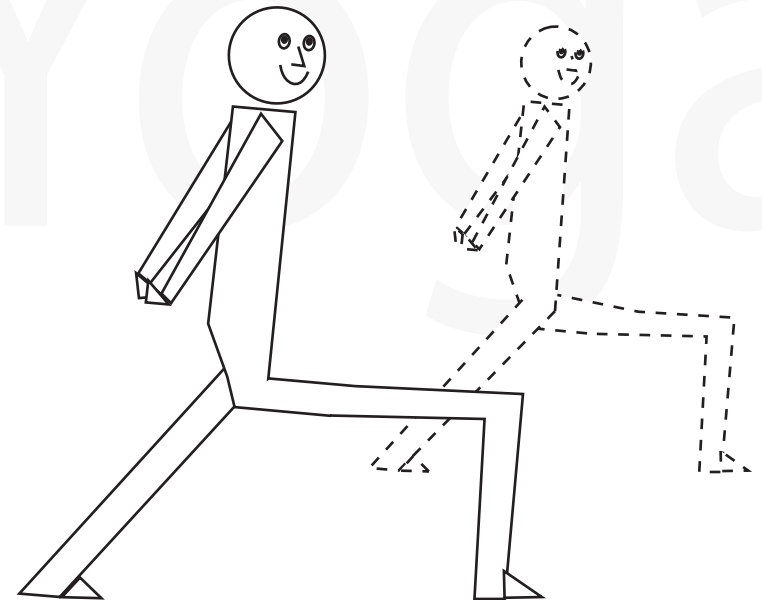

Satellite Pose

1. Stand tall, feet wide apart.
2. Place hands straight out at sides. (A)
3. Bend to left, left hand touching knee.(B)
4. Hold for 10 breath counts.
5. Return to center.(A)
6. Bend to right, right hand touching knee.(C)
7. Hold for 10 breath counts.
8. Return to center.(A)

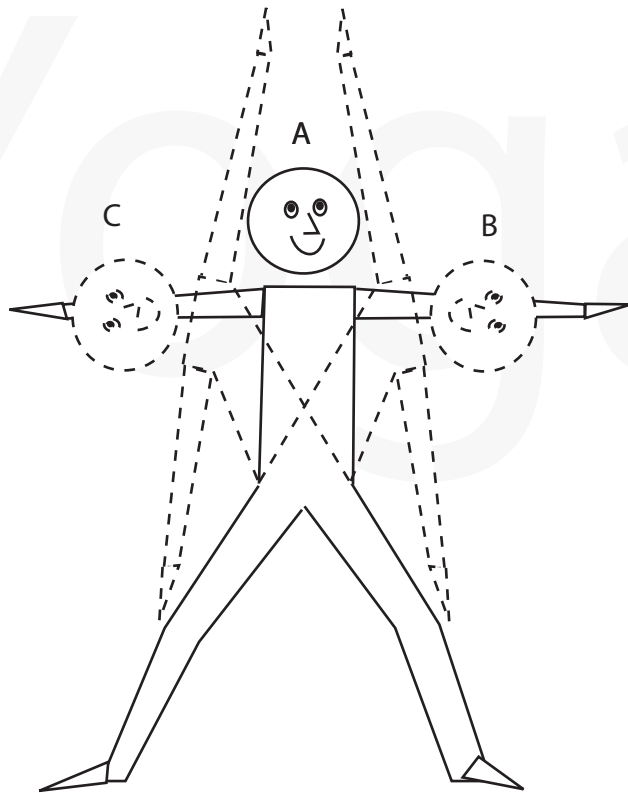

Peaceful Warrior Pose

1. Stand tall, feet wide apart.
2. Place hands straight out at sides. (A)
3. Bend left knee parallel to foot.(B)
4. Hold for 10 breath counts.
5. Return to center.(A)
6. Bend right knee parallel to foot.(C)
7. Hold for 10 breath counts.
8. Return to center.(A)

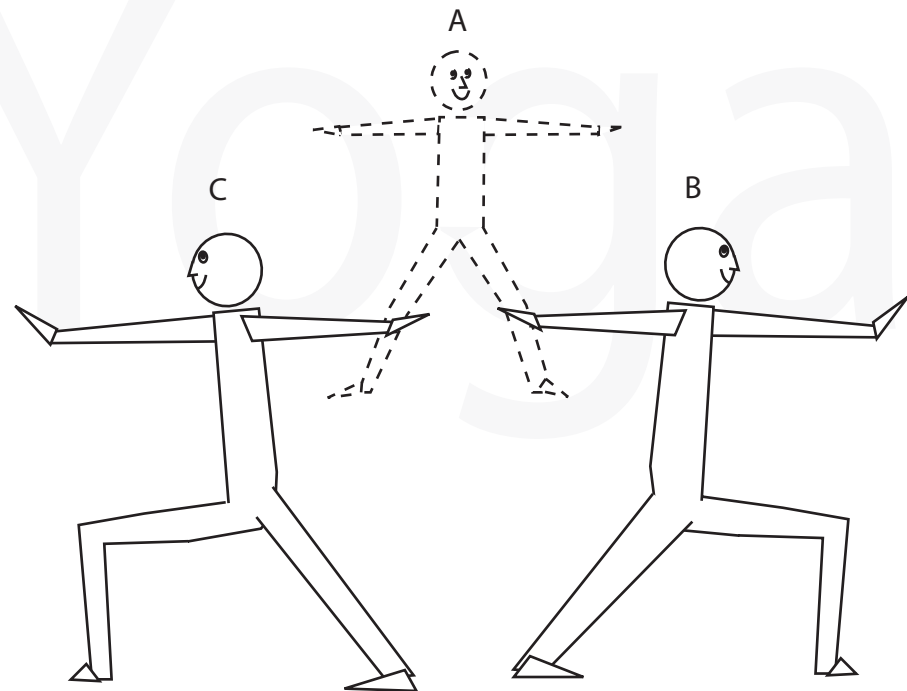

Spiral Pose

1. Begin with the Sitting On Legs Pose.
2. Sit bottom to left of feet.
3. Bend right knee towards chest.
4. Hands on legs .
5. Cross right foot over left leg, putting foot flat on floor.
6. Raise arms out to sides and twist to right.
- 7 Hold for breath counting.
8. Switch to other leg.
9. Work to 10 breath counts.

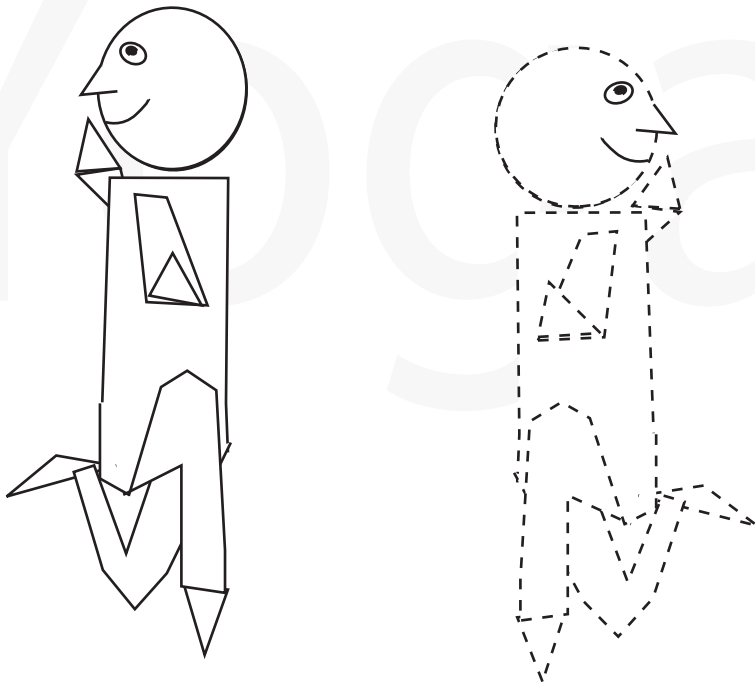

Prayer Pose

1. Stand straight .
2. Raise hands to chest, palms resting against each other.
3. Do 10 breath counts.

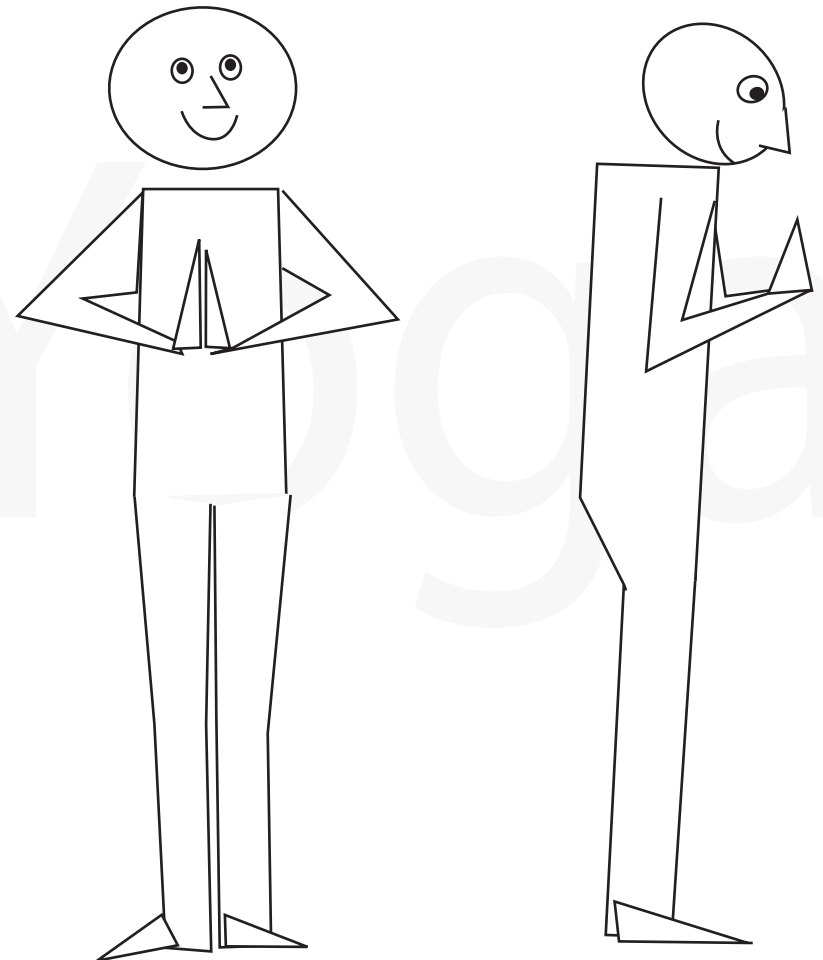

Sun Salutation

1. Begin with the Prayer Pose.(A)
2. Raise hands over head and lean back in the Crescent Moon Pose .(B)
3. Move into Willow Pose.(C)
4. Extend right leg back as far as possible.(D)
5. Move to Drawbridge Pose.(E)
6. Lay face down on floor.(F)
7. Move into Hope Pose.(G)
8. Move to Drawbridge Pose.(H)
9. Extend left leg back as far as possible.(I)
10. Move into Willow Pose.(J)
11. Raise hands over head and lean back in the Crescent Moon Pose.(K)
12. End by standing palms together hand raised to chest level in the Prayer Pose.(L)

